



300 Series City Softener Manual

Installation / Operation Manual

Specifications..... Page 4
Installation..... Page 6
Programming the Control Valve..... Page 10
Master Programming..... Page 11
Utilizing Bluetooth..... Page 12
Powerhead Assembly..... Page 15
Valve Body Assembly..... Page 16
Valve Body Parts..... Page 17
Bypass Assembly..... Page 18
Service Instructions..... Page 19
Troubleshooting..... Page 21
Error Codes..... Page 23
Warranty..... Page 24

Register Your Product
Online at
www.clearionwater.com



The logo for Clearion Water Technologies features the word "Clearion" in a bold, sans-serif font. A blue water droplet is positioned above the letter "i". A horizontal line with a slight curve passes through the middle of the word. Below the word, the words "WATER TECHNOLOGIES" are written in a smaller, all-caps, sans-serif font.

FCC Compliance Statement:
http://www.chandlersystemsinc.com/files/FCC_Combpliance_Statement.pdf

Industry Canada Compliance Statement:
http://www.chandlersystemsinc.com/files/Industry_Canada_Combpliance_Statement.pdf

One or more features of this product are covered by U.S. patents, visit <http://clearionwater.com/patents.php> for more information.

300 SERIES Softener Specifications

General Specifications	CLMC32	CLMC48
Regeneration Type	Metered	Metered
Catalytic Carbon Media	.5 cubic feet	1 cubic feet
Softening Capacity	27K Grains	40K Grains
Salt Used / Regeneration (pounds) ⁽¹⁾	9	15
Maximum Raw Water Hardness (grains)	75	100
Maximum Raw Water Iron (ppm)	5	5
Service Flow Rate (gpm) ⁽²⁾	5	8
Intermittent Flow Rate (gpm)	7	10
Backwash Flow Rate (gpm)	2.4	3.5
Mineral Tank Size	10 x 54	13 x 65
Gallons Used / Backwash	81	105
Space Required (DxWxH) in inches	18 x 28 x 62	18 x 31 x 73
Approximate Shipping Weight	130 lbs.	240 lbs.

WARNING

Lubricants

Do NOT use Vaseline, oils, hydrocarbon lubricants or spray silicone anywhere! Petroleum base lubricants will cause swelling of o-rings and seals. The use of other lubricants may attack plastic Noryl®. It is recommended that Dow Corning® silicone grease be used as a lubricant for all control valves. Dow Corning® 7 Release Compound is used in the manufacture of Chandler Systems control valves. (Part # LT-150)

Sealants

Pipe dope and liquid thread sealers may contain a carrier that attacks some plastic materials. It is recommended that Teflon® tape be used to seal plastic Noryl® threaded fittings.

PLEASE NOTE THESE SPECIFICATIONS BEFORE PROCEEDING

OPERATING PRESSURE RANGE : 20 - 125 PSI
OPERATING TEMPERATURE RANGE : 33° F - 120° F
INLET / OUTLET PIPE SIZE : 3/4" FNPT

PLEASE COMPLY WITH ALL APPLICABLE PLUMBING CODES

PROTECT THE SOFTENER AND PIPING FROM FREEZING TEMPERATURES

Please read the entire Owner's Manual and Instruction before installation.
This Owner's Manual must stay with the unit.

-How A Water Softener Works-

Water hardness is derived from Calcium and Magnesium minerals that have been dissolved into the water under the earth's surface. These minerals are found in limestone deposits and are the source of hard water. The amount of hardness in a given water supply is dependent upon the quantity of Calcium and Magnesium present and the length of time water has been in contact with them. This can vary dramatically from well-to-well and, for this reason, a water analysis is imperative in order to determine the proper treatment method. The degree of hardness increases as the concentration of Calcium and Magnesium "ions" increase and is measured in **Grains Per Gallon (gpg)**.

The problem of hard water in the home / business comes to light in many facets of daily use. Water spots and scum left behind on bathtubs, fixtures and showers; wear and tear on appliances; calcium build-up in hot water heaters and piping; and, greater amounts of soap and detergents being used are just a few examples.

The modern water softener is designed to reduce hardness ions and their unpleasant side effects. Special resin beads in the softener mineral tank are used to change hard water into soft water. The surfaces of these beads are covered with sodium ions. As hard water enters the mineral tank and comes into contact with the resin, an exchange of ions takes place as dissolved Calcium and Magnesium ions cling to the resin surface and sodium ions take their place, thus softening the water. This process is called **Ion Exchange**. Over time, the sodium ions used for the exchange process become depleted and must be replenished.

The water softener provides a **Regeneration** process whereby brine solution enters the mineral tank, driving-off the collected hardness ions and replenishes the surface of the resin beads with more sodium ions. This process is automatically initiated by the control valve on the mineral tank. The regeneration process has five basic cycles as follows:

1. **Backwash** - The control valve directs the water flow in a reverse direction through the mineral tank, separating the resin beads and flushing any accumulated particles to a waste drain.
2. **Brine & Rinse** - In the first part of this cycle, the control valve directs brine solution downward through the mineral tank, driving-off collected hardness ions and replenishing the resin beads with sodium ions. The second part of the cycle rinses hardness ions and excess brine from the mineral tank to the waste drain.
3. **Rapid Rinse** - The control valve directs the water flow downward, settling and recompacting the resin bed.
4. **Brine Refill** - The control valve directs fresh water into the salt compartment to create new brine solution for the next scheduled regeneration.
5. **Service** - This is the normal "operating" cycle where hard water enters the mineral tank, comes into contact with the resin beads and exchanges hardness ions for sodium ions - the water then becomes "soft" and ready for use.

-Pre-Installation Check List-

A water test should always be performed in order to determine total water hardness (in gpg) and total dissolved iron (in parts per million - ppm). This is critical for proper equipment selection, sizing and for determining the program for regeneration frequency. If heavy concentrations of iron (above 5 ppm), iron coloration, iron bacteria or sediment are present, filtration prior to the softener will most generally be required. Certain states may require a licensed plumber for installation.

Note: Flexible water supply connectors and flexible drain line tubing may not be allowed in you locale. Please check with local plumbing code officials prior to installation.

Installation Requirements

- A level floor position ahead of piping into water heater.
- Unit must be installed at least 10' ahead of the inlet to a water heater to prevent damage due to back-up of hot water.
- **DO NOT** install the unit in an area of direct sunlight or where freezing temperatures may occur!
(See Installation Diagrams for proper placement and plumbing connections.)

-Major System Components-

1. **Brine Tank** - This tank holds the salt that is added to the softener. This salt is dissolved with water to form a brine solution used in the softener regeneration process.
2. **Resin Tank** - This tank contains the ion exchange resin media. Water flows through the resin tank under pressure to come into contact with the resin for water softening.
3. **Control Valve** - The valve directs water through the resin tank for water softening and controls the flow of water / brine for the regeneration process.

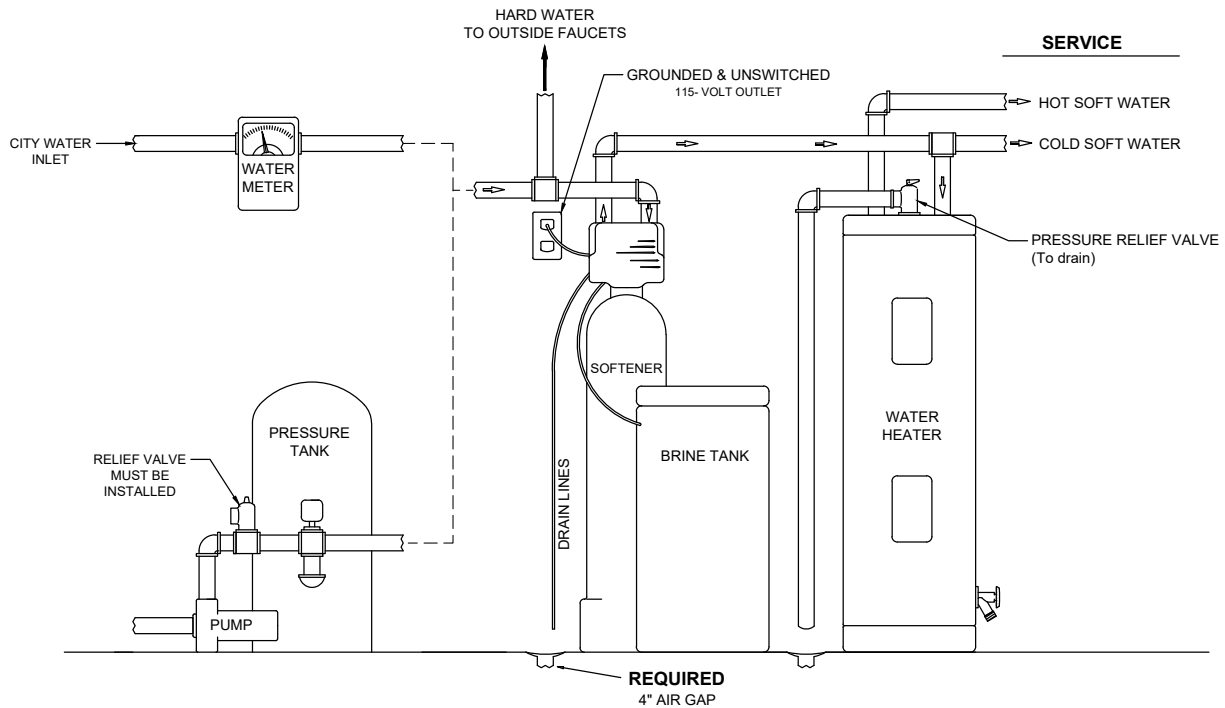

-Softener Location / Other Requirements-

- Locate the unit near an unswitched, 120 volt / 60 Hz grounded electrical outlet.
- Check for distance and proper drain installation (e.g. floor drain, washing machine standpipe).
- Determine type and size of piping required for softener connection (e.g. copper, galvanized, PVC plastic).

Note

- If household plumbing is galvanized and you intend to make the installation with copper (or vice versa), obtain di-electric unions to prevent dissimilar metal corrosion.
- Where the drain line is elevated above the control valve or exceeds 20 feet in length to reach the drain, use 3/4" I.D. drain line tubing instead of 1/2" I.D. Drain line tubing is not included.
- All plumbing lines not requiring "soft" water should be connected "upstream" of the softener.
- The brine tank drain line is gravity flow and must discharge below the overflow fitting.
- The brine overflow is provided as a back-up in the event the safety float shut-off should fail, allowing the brine tank to overflow. This drain connection would then carry the excess water to the drain and prevent flooding of the floor. Therefore, no liability will or can be assumed by the manufacturer of the softener should this occur.

Caution

- If sweat soldering copper pipe (remember to always use lead free solder and flux), cover yoke and bypass valve with wet rags to prevent heat damage to connections and control valve! If using PVC or plastic pipe primers and solvent cements specifically recommended for use with potable water are required.
- Do not "TEE" to the main drain line from control valve.

-Installation Procedure-

- Water Supply Connections and Bypass Valve -

To allow for softener servicing, swimming pool filling or lawn sprinkling, a manual bypass valve has been installed at the factory. The bypass allows hard water to be manually routed around the softener.

1. Position softener at desired location for installation. (See Installation Diagrams.)
2. Turn OFF main water supply and OPEN nearest faucet to relieve pressure.
3. Cut main line and install appropriate elbows and extensions.

Caution : Raised arrows located on the sides of control valve body and bypass valve indicate proper direction of water flow. Install inlet and outlet piping in direction of arrows. It is recommended that a vacuum breaker be installed on the inlet plumbing.

4. Rotate bypass valve to the bypass position (position of lever is at right angle to inlet / outlet piping).
5. Turn the main supply line on to restore water service to the home.
6. OPEN nearest faucet to evacuate air and repressurize plumbing lines.
7. Check for leaks!

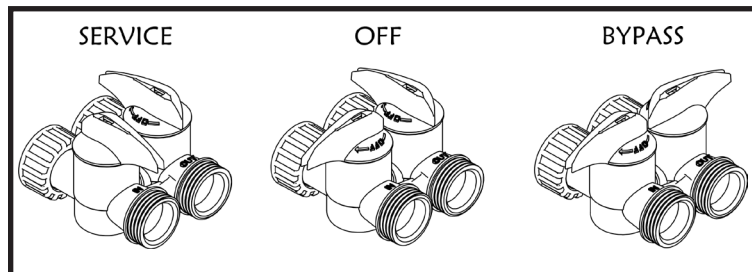

- Drain Line Connection -

1. The drain line flow control assembly is pre-assembled for your convenience. Should you choose to hard plumb the drain line, please remove the barb fitting. The flow control housing can be removed by removing the clip and pulling straight out on housing.

Note: When re-installing the drain line flow control housing, be sure you hear and feel the O-Ring pop into place before inserting the clip.

2. Install 1/2" I.D. drain line tubing (not included) from hose barb to an open drain. A 4" gap between end of the drain line and the open drain is required to prevent waste water backflow. Keep the drain line as short as possible. An overhead drain line can be used if necessary, but should discharge below the control valve. A syphon trap (taped loop) at the outlet of the drain line is advisable to keep the drain line full and assure correct flow during backwash. Elbows or other fittings must be kept at a bare minimum.

Note: Where the drain line is elevated above the control valve or exceeds 20 feet in length, 3/4" I.D. drain line tubing should be used.

-Brine Line and Overflow Connection-

Note: Your brine tank comes with two brine lines. Black is for outdoor installation. Opaque is for indoor installation.

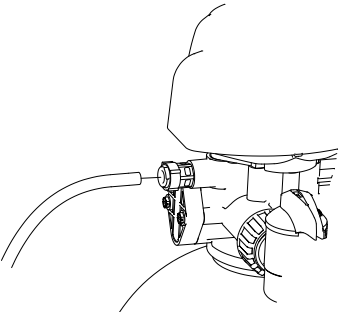
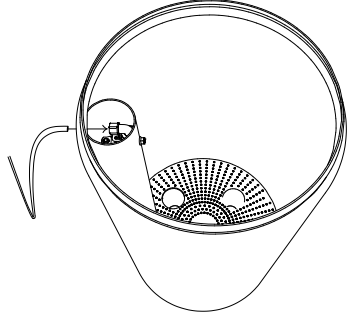
<p>Feed one end of brine line to brine line connection on control valve. Firmly insert it all the way into the push lock fitting. When the tubing is fully inserted, the filling will grab the tubing and hold it in place. A compression insert is NOT needed.</p>	<p>Inside the brine tank, remove the cap from the top of the brine well. Feed the other end of the brine tubing through the hole in the side of the brine tank, and firmly insert it all the way into the push-lock elbow fitting inside the brine well. When this tubing is fully inserted, the fitting will grab the tubing and hold it in place.</p>
	

BRINE LINE CONNECTION TO CONTROL VALVE

BRINE LINE CONNECTION TO BRINE TANK

- Electrical Connection -

1. Connect the power cord and plug power supply into a 115 volt / 60 Hz receptacle.

Note: Do not plug into an outlet controlled by a wall switch or pull chain that could inadvertently be turned off

Electronic Connections

P = Power Supply

B = Powered in Backwash Step Only (Cycle #1)

S = Powered for Entire Regen. Cycle



- Pressurizing The System -

1. Make certain the Control Valve is in **SERVICE** position.
2. Slowly rotate bypass valve to the **SERVICE** position. (Position of bypass lever is parallel to inlet / outlet piping.)
3. Open the nearest faucet to evacuate air from plumbing lines.
4. Check for leaks! If water is observed leaking from bottom of bypass, close and open bypass lever several times to seat o-rings. Exercise bypass valve.
5. After air is evacuated from plumbing lines, close bypass (position of bypass lever is perpendicular to the direction of inlet pipe) on bypass valve.

Note: Salt settings are pre-set at the factory for the maximum shown on the capacity charts.

Warning: Do not reduce salt settings below 9 lbs. as the water level in the brine tank will not reach the grid plate.

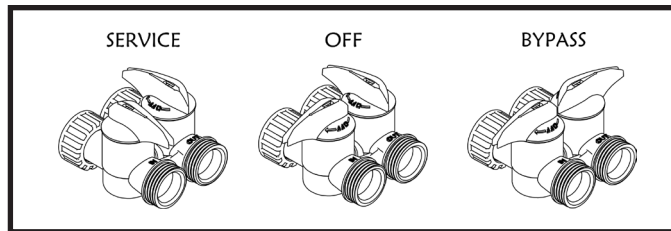

Main Menu

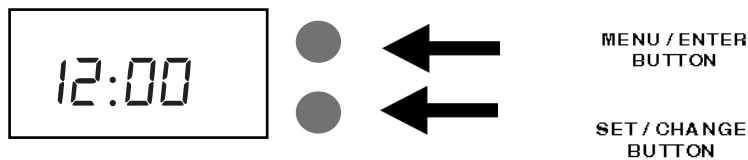

1. To enter Main Menu, press the **Menu/Enter** button.
(Time of Day will flash)
 2. To set the **Time of Day**, press the **Set/Change** button.
(First digit will flash)
 - To change digit value, press the **Set/Change** button.
 - To accept the digit value, press the **Menu/Enter** button.
 - Next digit will flash to begin setting.
 - Once the last digit display is accepted, all digits will flash.

Example [12-00]
 3. To set **A.M.** or **P.M.**, press the **Menu/Enter** button.
 - To change digit value, press the **Set/Change** button.
 - To accept the digit value, press the **Menu/Enter** button.
 - Once A.M. or P.M. is accepted, the next menu item will flash.

Example [A]
 4. a. To set the **Number of Days between Regeneration (A)**, press the **Set/Change** button. (**Time Clock Softeners**)
 - Repeat instructions from step (2).

Example [A - 07]

Notes: 1) Maximum value is 29.
 2) If value set to 0, Regeneration will never occur.
 3) Default setting is 4 days for softeners.

 - b. To set **Hardness (Metered Softeners Only)** an "H" will appear to enter Compensated Hardness in grains per gallon (gpg) Default setting is 25 gpg.

Example [H - 25]
5. To Exit Main Menu, press the **Menu/Enter** button.
 Note: If no buttons are pressed for 60 seconds, the Main Menu will be exited automatically.

Normal Operation

1. Home Display



- a. **Time Clock Softeners** -Alternates between the display of Time of Day and Number of Days until the Next Regeneration.
 - Days Remaining until the Next Regeneration will count down from the entered value until it reaches 1 day remaining.
 - A Regeneration Cycle will then be initiated at the next designated regeneration time.
- b. **Metered** models alternate the Time of Day and Gallons left until the next regeneration. The meter will count down to zero (0000) and then regenerate at the scheduled time set.

2. Battery Back-Up (Uses a standard 9-volt alkaline battery.)

Features of Battery Back-Up:

- During power failures, the battery will maintain the time of day as long as the battery has power. The display is turned off to conserve battery power during this time. To confirm that the battery is working, press either button and the display will turn on for five (5) seconds.
- If power failure occurs while system is regenerating, the will motor to a shut off position to prevent constant flow to drain. Depending upon system pressure and other factors, it is possible to observe a reduced flow to drain during this step. After power is restored, the Signature 2 will return and finish the cycle where it left off prior to the power interruption.
- When used without battery back-up, during a power failure, the unit stops at its current point in the regeneration position and then restarts at that point when the power is restored. The time will be offset by the increment of time the unit was without power, so it is necessary to reset the time of day on the unit. No other system will be affected.

Starting Extra Regeneration Cycle

1. To Start **Delayed Extra Cycle** Example [/]
 - If Days Remaining Until Next Regeneration does not read '1', press and hold the **Set/Change** button for 3 seconds until the display reads '1', or '0000' on metered models.
 - Regeneration cycle will initiate at the next designated regeneration time.
2. To start **Immediate Extra Cycle**  First complete above step.
 - With Days Remaining Until Next Regeneration at '1' or '0000',
 - Press and hold the **Set/Change** button.
 - After 3 seconds, the regeneration cycle will begin.
3. To **Fast Cycle** thru regeneration  First complete above 2 steps.
Note: Press and hold the **Set/Change** button for 3 seconds to advance to the next cycle step.
 Fast Cycle is not necessary unless desired to manually step through each cycle step.
 (Repeat until valve returns to the home display)

Softeners	Default (Min)	
Step 1	Backwash	10
Step 2	Brine & Rinse	60
Step 3	Rapid Rinse	10
Step 4	Brine Refill	9 lbs/ cu ft

Master Programming Mode

To enter Master Programming Mode, press and hold both buttons for 5 seconds.

Note: All Master Programming functions have been preset at the factory. Unless a change is desired, it is **NOT** necessary to enter Master Programming Mode.

1. Regeneration Time (r)

Example [r 2A]

- The time of day at which regeneration may take place is designated by the letter “r”.
- Default regeneration time setting for **SOFTENERS is 2a**
- The first display digit indicates A.M. or P.M. To change the value, press the **Set/Change** button.
- Press **Menu/Enter** button to accept the value and move to the next digit.
- The second and third display digits indicate the hour at which the regeneration will occur.
- Change the digits with the **Set/Change** button and accept with the **Menu/Enter** button.
- After the entire display flashes, press the **Menu/Enter** button to move to the next menu item.

2. Regeneration Day Override (A) – Meter (Demand) Mode Only

- Press **Menu/Enter** button. This display is used to set the maximum amount of time (in days) the unit can be in service without regeneration. This setting is identified by the letter “A” in the left digit. Regeneration will begin at the scheduled time. A setting of zero will cancel this feature.
- Example: Override every 7 days (A-07), default setting, or cancel setting (A-00). Maximum is 29.

3. Regeneration Cycle Step Times (Steps 1, 2, 3, 4)

Example [3 - 10]

- The next 4 displays set the duration of time in minutes for each regeneration cycle step.
- The step number which is currently modifiable is indicated on the far left of the display screen.
- The number of minutes allotted for the selected backwash step is displayed on the far right.
- Change the digit values using the **Set/Change** and **Menu/Enter** buttons as described above.

4. System Capacity in Grains (c) – Meter (Demand Mode Only)

- Press the **Menu/Enter** button. This display is used to set the system capacity in grains and is used in conjunction with the hardness setting to calculate total gallons of treated water available between regenerations. This option is identified by the letter “c” in the left digit. The maximum value for this item is 399. Example: 32,000 grain capacity (c 032).

5. Reserve Capacity Setting %

Example (P - 25)

6. Bluetooth Enabled

bE - 1 (ON)
bE - 0 (OFF)

7. Bluetooth Password

bbPP is displayed for one second, then password is displayed.

8. To Exit the Master Programming Mode, press the **Menu/Enter** button until time of day returns.

Note: If no buttons are pressed for 60 seconds, the Master Programming Mode will be exited automatically.



For simplified set up and control, please install the Legacy View on a compatible Bluetooth 4.0+ enabled smart phone or tablet.

1. Download and install the Legacy View app from the Google Play Store, Apple App Store



2. Open the Legacy View app

- Choose a valve device at any time from the list of available devices to connect to by clicking on it.
- If the valve you want to connect to doesn't show up, or there is a problem connecting to a device you can press the "Scan for Devices" button or the Legacy View logo at any time to refresh the list and start the process over.
- If the valve device is a BTLE valve and it has a password other than the default password, the first time you connect to it the app will ask you to enter the password. After entering it the first time you should not need to enter it again unless it changes.

3. BTLE Valve devices can be updated by the App. When the app is updated from the Google Play Store or the Apple App Store, it may contain an updated firmware program for the valve devices. These updates could contain new features or operational improvements. It is up to the user to allow these updates to be sent to the valve device. Uploading a new program takes approximately 1 minute.

Dashboard

NOTE: Consult your dealer before making any changes

From the **Dashboard**, all items in **ORANGE** can be changed, while blue fields are informational only.

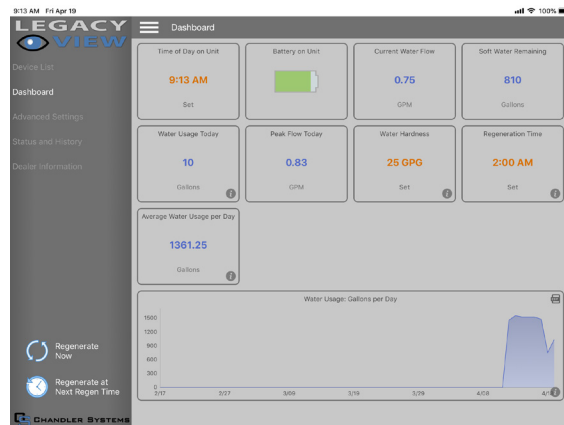

If you are unsure about the function of the field click the  for more information.

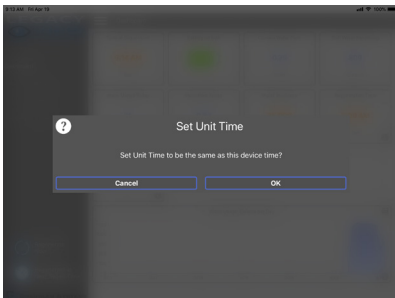

Change Time of Day (Press “SET” to set time automatically based on device).

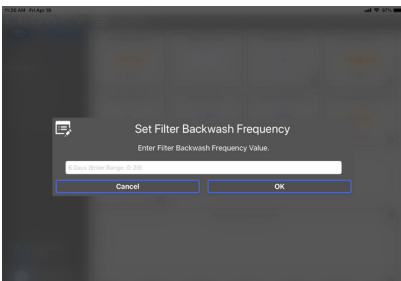

For Filters:
Set Backwash Frequency
This sets the amount of day between backwash cycles

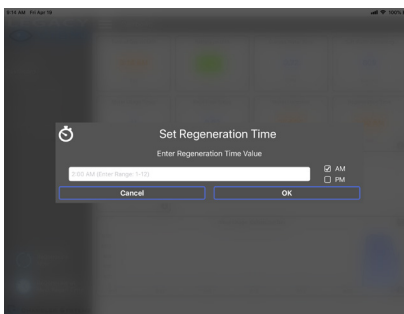

Set Regeneration Time
Example: For 2a.m., just type 2, choose a.m., and press ‘OK’
Note: If you have a filter and a softener the valves should be set to regenerate at different times. Factory default times are 12a.m. for filters, and 2 a.m. for softeners.

Advanced Settings

NOTE: Consult your dealer before making any changes. We do not recommend changing Advanced Settings unless you have a good understanding of the system operation.

From the **Advanced Settings**, all items in **ORANGE** with a “set” button can be changed.

Status and History

From the **Status and History**, all items in **ORANGE** can be reset.

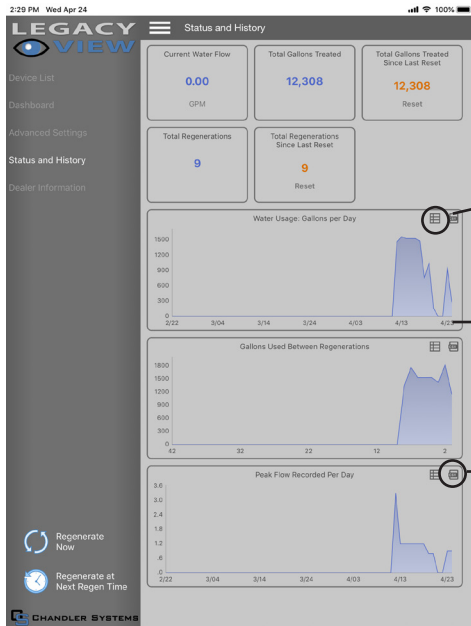

Pressing this icon will show a list of the data that is in the graph

Touch any graph to enlarge and see details. Enlarged graphs are able to be zoomed in by pinching with two fingers. (Enlarged graph shown below)

Pressing the .csv logo in the corner will allow the graph data to be exported and shared.

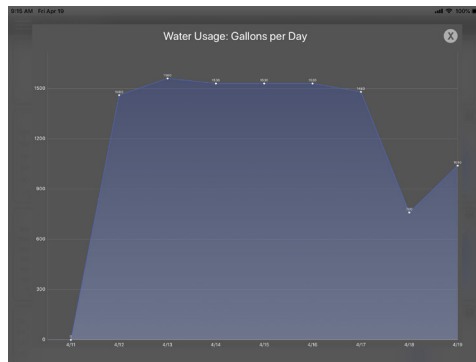

Enlarged graph showing water usage

1. Start a regeneration or backwash cycle

Option 1:

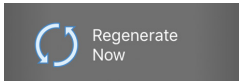

Click the “Regenerate Unit Now.”

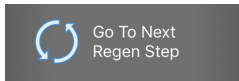

Once a regeneration has been started, if you would like to force the unit into the next cycle step click “Go to Next Regeneration Step”.

Option 2:

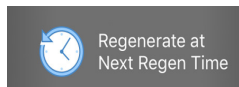

“Regenerate Unit at Next Regen Time” button
 This will take the system into a backwash cycle at the next regeneration time.

300 SERIES Powerhead Assembly

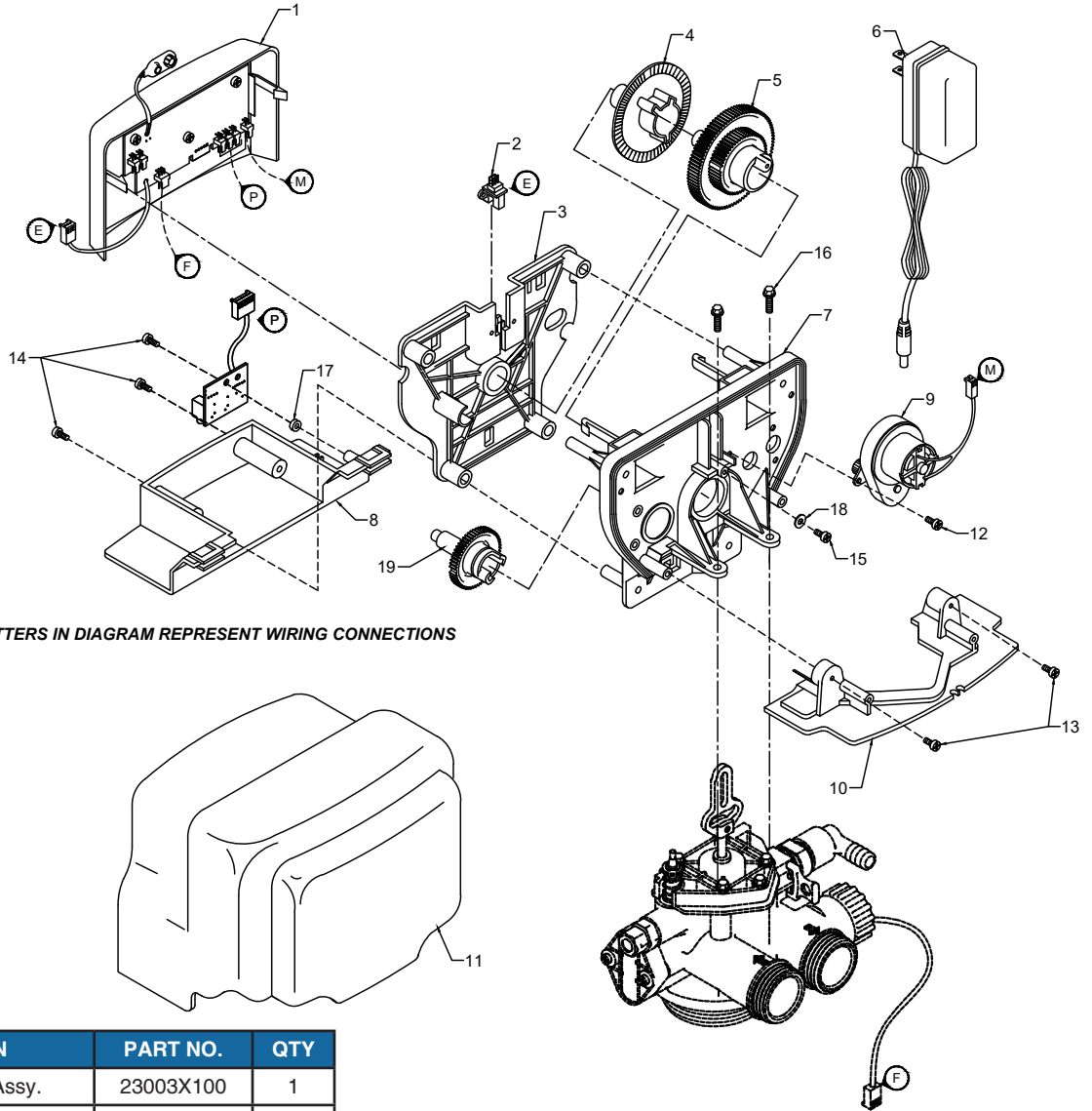

REF	DESCRIPTION	PART NO.	QTY
0	Metered Power Head Assy.	23003X100	1
1	Softener Circuit Boad Assy.	23003X102	1
2	Encoder	20001X124	1
3	Front Plate	20001X004	1
4	Encoder Wheel	20001X007	1
5	Main Gear	21001X120	1
6	Power Supply	20001X125	1
7	Back Plate	20001X005	1
8	Lower Front Base For Cover	20111X002	1
9	Legacy View Motor Assy.	20016X006	1
10	Lower Back Base for Cover	20111X003	1
11	Valve Cover	20111X017	1
12	6 X 1/2" Slotted, Hex Head	20001X003	1
13	6 X 1/2" Phillips, Pan Head	SC10	3
14	6 X 1/2" Slotted, Hex Head Blk	SC9	2
15	6 X 1/2 Fenderwasher SST	20001X002	1
16	Washer Circuit Board	20111X014	1
17	6-32 X 5/16" Phillips, Pan Head	SC2	1
21	10-24 X 3/4" Screw SST	20001X001	2

300 SERIES
Valve Body Assy.

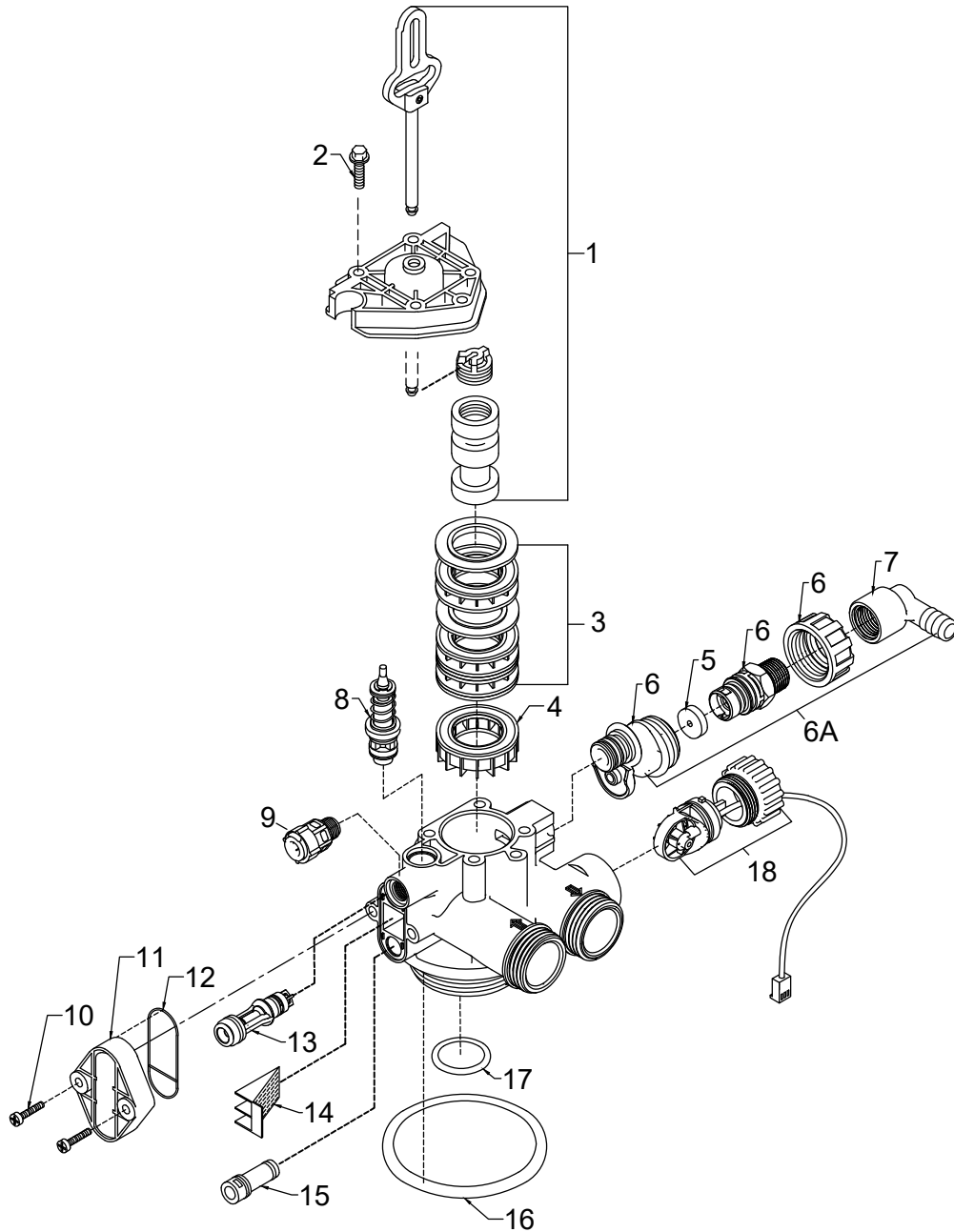

REF	DESCRIPTION	PART NO.	QTY
1	Piston Assembly	20001X231	1
2	10-24 X 3/4" Screw SST	20001X001	3
3	Seal and Spacer Kit	20561X253	1
4	End Spacer	20001X234	1
5	Flow Control Button 1.5 GPM	20251X266	1
	Flow Control Button 2.0 GPM	20251X267	1
	Flow Control Button 2.4 GPM	20251X268	1
6A	DLFC Assy.	20017X251	1
7	90 Degree Hose Barb Elbow	20017X266	1
8	Brine Valve	20561X225	1
9	Brine Line Connection	20561X006	1
10	10-24 X 3/4" Screw SST	20001X001	2
11	Injector Cap	20001X223	1
12	Injector Cap Seal	20001X224	1
13	Injector, White	20017x219	1
	Injector, Blue	20017x220	1
14	Injection Screen	20001X222	1
15	Plug	20001X217	1
16	Tank. O-Ring	20015X043	1
17	Dist. O-Ring	20561X204	1
18	Meter Assembly	20017X203	1

300 SERIES
Bypass Assembly

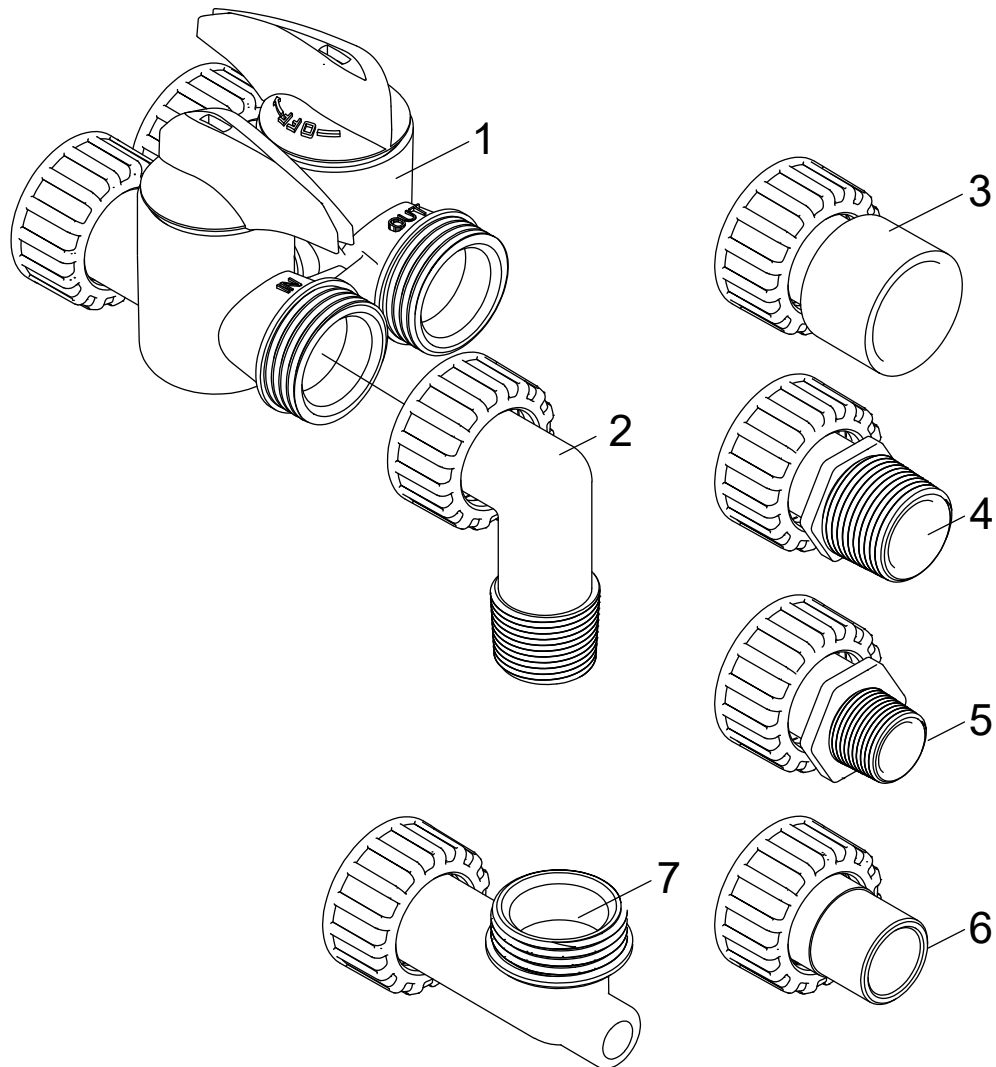

REF	DESCRIPTION	PART NO.
1	D15 Bypass (included with all units)	20017X283
2	1" NPT Elbow Set (included with all units)	20017X284
3	1" Female Straight Slip Set (optional)	20017X288
4	1" NPT Straight Set (optional)	20017X289
5	3/4" NPT Straight Set (optional)	20017X307
6	3/4" Female Straight Slip Set (optional)	20017X290
7a	Elbow, Vertical Adapter Blank (optional)	20017X295
7b	Elbow, Vertical Adapter 1/4" NPT Tapped (optional)	20017X294

A. General Preliminary Instructions

PERFORM BEFORE ALL SERVICING OPERATIONS

1. Turn off water supply to conditioner.
 - If the conditioner installation has a “three valve” bypass system, first open the valve in the bypass line, then close the valves at the conditioner inlet and outlet.
 - If the conditioner has an integral bypass valve, put it in the bypass position.
 - If there is only a shut off valve near the conditioner inlet, close it.
2. Remove cover and relieve water pressure in the conditioner by stepping the control into the backwash position momentarily. Return the control to the service position.
3. Unplug electrical cord from outlet.

B. To Replace Powerhead

1. Remove the control valve cover and disconnect the power supply.
2. Disconnect the meter cable from circuit board and feed back through control (if existing meter is being re-used)
3. Remove lower back base screws and detach lower back base.
4. Remove screw and washer at drive yoke. Remove powerhead mounting screws. The entire powerhead assembly will now lift off easily.
5. Put new powerhead on top of the valve. Be sure the drive pin on main gear engages slot in drive yoke (wide side of drive yoke upright must face to the left away from the motor).
6. Replace powerhead mounting screws. Replace screw and washer at drive yoke.
7. Reattach lower back base.
7. Reconnect meter signal, wire and power supply.
8. Reinstall cover.

C. To Replace Piston Assembly

1. Follow steps **A1 - A3**
2. Disconnect the meter signal wire from the circuit board.
3. Remove lower back base screws and detach lower back base.
4. Remove screw and washer at piston drive yoke. Remove powerhead mounting screws. The entire powerhead assembly will now lift off easily.
5. Remove piston retaining plate screws.
6. Pull upward on end of piston yoke until assembly is out of valve.
7. Inspect the inside of the valve to make sure that there is no foreign matter that would interfere with the valve operation.
8. Install new seals and spacers.
9. Take new piston assembly and push piston into valve by means of the end plug. Twist drive yoke carefully in a clockwise direction to properly align it with drive gear. Reinstall piston retaining plate screws.
10. Follow steps **B5 - B9**

D. To Replace Seals and Spacers

1. Follow steps **A1 - A3**.
2. Disconnect the meter signal wire from the circuit board.
3. Remove screw and washer at piston drive yoke. Remove powerhead mounting screws. The entire powerhead assembly will now lift off easily. Remove piston retaining plate screws.
4. Pull upward on end of piston rod yoke until assembly is out of valve. Remove seals and spacers. (Note: Special end spacer must be reused)
5. Lubricate new seals with silicone lubricant included in the seal and spacer kit. Make sure the special end spacer is properly seated in the valve body. Install new seals and spacers individually, pressing around the outer edge of each seal to make sure it is seated. (When all seals and spacers are seated properly, you will have a 1/4” of space between the top seal the the top of the valve body)
6. Follow Steps **C9 - C10**.

E. To Service Injector and Screen

1. Follow steps A1-A2.
2. Unscrew injector cover screws and remove injector cover.
3. Remove injector screen and clean or replace.
4. Remove injector and clean or replace.
5. Apply silicone lubricant to injector seal and replace cover and screws.

F. To Replace Meter

1. Follow steps **A1 - A3**
2. Unplug meter cable from front of circuit board.
3. Unscrew meter assembly nut from valve body.
4. Remove meter from valve body and clean or replace as necessary.
5. Reinstall meter, nut and cable.

G. To Replace Brine Valve

1. Follow Piston Replacement instructions. After the piston is removed, pull the brine valve from the valve body.
2. Inspect brine valve cavity in valve body and remove any foreign matter that would interfere with brine valve operation.
3. Apply silicone lubricant to brine valve O rings and push the new brine valve into the valve body.
4. Continue following Piston Replacement instructions to reinstall piston and powerhead

SYMPTOM	PROBABLE CAUSE	CORRECTION
1. Softener Fails to Regenerate Automatically	Power supply plugged into intermittent or dead power source	Connect to constant power source
	Disconnected meter cable	Reconnect cable
	Improper control valve programming	Reset program settings
	Defective power supply	Replace power supply
	Meter is dirty or defective	Clean or replace meter assembly
	Defective Drive motor	Replace motor
2. Regeneration at Wrong Time	Time of day improperly set, due to power failure	Reset time of day programming and install 9-volt battery.
	Regeneration time set improperly	Reset regeneration time programming
3. Loss of Capacity	Increased raw water hardness	Increase hardness setting or decrease days between regeneration
	Brine concentration and or / quantity	Keep brine tank full of salt at all times. Clean it yearly. Salt may be bridged. If using a salt grid plate, ensure refill water is over it.
	Resin fouling	Call dealer. Find out how to confirm it. Clean the resin and prevent future fouling.
	Poor distribution, channeling (uneven bed surface)	Call dealer. Check backwash flow. Regenerate more frequently
	Internal valve leak	Call dealer. Replace spacers, seals and / or piston
	Resin age	Call dealer. Check for resin oxidation caused by chlorine. Mushy resin.
	Resin loss	Call dealer. Check for correct bed depth. Broken distributor tube. Air or gas in bed: well gas eliminator. Loose brine line.
4. Poor Water Quality	Check items listed in #1, #2, and #3	
	Bypass valve open	Close bypass valve.
	Channeling	Check for too slow or high service flow. Check for media fouling.
5. High Salt Usage	High salt setting	Lower brine tank refill time
	Excessive water in brine tank	See symptom #7
	Constant flow through the unit	Indicates plumbing leak (e.g. toilet tank)
	Regenerating too frequently	Lower hardness setting or increase days between regeneration.
6. Loss of Water Pressure	Scaling / fouling of inlet pipe	Clean or replace pipeline. Pretreat to prevent.
	Fouled resin	Clean resin. Pretreat to prevent.
	Improper backwash setting	Backwash more frequently

SYMPTOM	PROBABLE CAUSE	CORRECTION
7. Excessive Water in Brine Tank and / or Salty Water to Service	Plugged drain line or drain line control	Check flow to drain. Clean drainline flow control button
	Dirty or damaged brine valve	Clean or replace brine valve.
	Plugged injector or screen	Clean or replace injector screen.
	Low inlet pressure	Increase pressure to allow injector to perform properly. (20 psig minimum)
	Excessive brine refill cycle time	Lower brine refill time.
8. Softener Fails to Use Salt	Check items listed in #1	
	Improper control valve programming	Check and reset programming
	Plugged / restrict drain line	Clean drain line and / or flow control button
	Injector and / or screen is plugged	Clean or replace injector and screen
	No water in brine tank	Check for restriction in BLFC. Ensure safety float is not stuck. Check brine tank for leaks.
	Water pressure is too low	Line pressure must be at least 20 psi.
	Brine line injects air during brine draw	Check brine line connections for air leaks
	Internal control leak	Call dealer. Check piston, seals and spacers for scratches and dents.
9. Continuous Flow to Drain	Foreign material in control piston and seals	Call dealer. Clean valve and replace piston and seals.
	Internal control leak	Same as above.
	Valve jammed in backwash, brine or rapid rinse position	Same as above.
	Motor stopped or jammed	Check for jammed piston. Replace piston and seals. Replace motor if motor is unresponsive.

Control Valve Error Code Diagnosis

Under normal operating conditions, when your control valve is in the “in service” position, the display should alternate between the current time of day and the number of days remaining (for filters and time clock softeners) or gallons remaining (for metered softeners) until the next regeneration. This is the “home display.” If the valve is currently going through a regeneration cycle, the display will show the cycle step on the left side of the display and the number of minutes remaining in that step on the right side of the display. If any other information is being displayed, then the valve is informing you of an issue. There are five error codes which could indicate an issue with the control valve. When an error is being displayed, the valve will be in a stopped position, and the buttons will not respond to being pressed. Even if the cause of the error code is corrected, the error code will not clear until the power supply has been disconnected and reconnected (this will be referred to as “cycling” the power). All error codes are displayed as the letters “Err” followed by a flashing number 2-6:

Error 2 - Valve is searching for homing slot.

Allow valve to continue running. If the homing slot is found, the valve will return to the home display, otherwise, another error code will appear.

Error 3 - No encoder slots are being seen.

This occurs when the motor is running, but the encoder is not seeing any of the slots in the encoder wheel. This can happen if the encoder has been disconnected, but most commonly occurs when debris in the valve body has stopped the piston, causing the encoder wheel to be unable to turn.

1. Check encoder connection. If the encoder is plugged in and snapped into place, skip to step #2 below. If encoder is disconnected, reconnect it and cycle power to clear the error.
2. Disconnect powerhead from valve body, cycle power to clear the error code. Manually cycle the powerhead through the regeneration cycle steps to verify that the motor can cycle properly while the powerhead is disconnected from the valve body. If the error 3 does not reappear, skip to step #3 below. If the error 3 does reappear, order a board & motor kit to replace the circuit board & motor.
3. Remove piston and seals from the valve body and inspect valve body for debris. Replace the seal & spacer kit. Inspect piston and replace piston if Teflon coating is worn

Error 4 - Unable to find homing slot.

1. Check encoder wheel for debris.
2. Cycle power. Valve should either find home or go to a different error code. If error 4 returns, replace powerhead assembly.

Error 5 - Motor overload.

This occurs when the motor current is too high. This could be caused by an issue with the motor itself, but is typically caused by friction in the valve body

1. Disconnect powerhead from valve body and cycle power to clear the error code.
2. If the error 5 returns, replace the motor. Otherwise, manually cycle the powerhead through the regeneration cycle steps to verify that the motor can cycle properly while the powerhead is disconnected from the valve body. Either way, proceed to the next step.
3. Remove piston and seals from the valve body and inspect valve body for debris. Replace the seal & spacer kit. Inspect piston and replace piston if Teflon coating is worn.

Error 6 - No motor current.

This typically occurs if the motor cable has come unplugged from the circuit board. Check that the motor cable is plugged into the circuit board and attached to the motor. If this is not the issue, the motor or circuit board may need to be replaced.

No Display

If your display is blank, there is no power going to the circuit board due to one of the following factors:

- The electrical outlet is not powered or is switched off
- The power cable has come unplugged from the circuit board
- The power supply has come unplugged from your electrical outlet
- The power supply has come unplugged from the control valve
- The power supply is not working

WATER TREATMENT EQUIPMENT

This warranty cannot be transferred - it is extended only to the original purchaser or first user of the product. By accepting and keeping this product, you agree to all of the warranty terms and limitations of liability described below.

Important Warning: Read carefully the ClearionWater Treatment Systems Equipment Installation, Operating and Maintenance Instructions Manual to avoid serious personal injury and property HAZARDS and to ensure safe and proper care of this product.

Model Numbers Covered:
Water Softeners, Media Filters and Upflow Filters

*FOR AS LONG AS YOU OWN AND LIVE IN YOUR SINGLE FAMILY HOME, this warranty covers your water treatment equipment, if you are the first user of this ClearionWater Treatment Systems equipment and purchased it for single family home use - subject to all of the conditions, limitations and exclusions listed below. Purchasers who buy the ClearionWater Treatment Systems equipment for other purposes, and other component parts are subject to more limited warranties and you should read all of the terms included in this form to make sure you understand your warranty.

What is covered by this warranty?
ClearionWater Treatment Systems warrants that at the time of manufacture, the water treatment equipment shall be free from defects in material and workmanship as follows :

Product	Warranty
Residential Mineral Tank	10 Years
Proprietary Control Valves	7 Years
Other Softener / Filter Control Valves	5 Years
Brine Tank	5 Years
Residential Reverse Osmosis System	5 Years
Other Accessories and Parts	1 Year
Brine Tank Components	1 Year
REVERE Wireless Low Salt Alarm	90 Days

* This warranty does not include media and/or cartridge filter elements.

Additional Terms & Conditions

What Clearion Water Treatment Systems will do if you have a covered warranty claim Clearion will at its option either make repairs to correct any defect in material or workmanship or supply and ship either new or used replacement parts or products. Clearion will not accept any claims for labor or other costs.

Additional Exclusions and Limitations

This warranty is non-transferable and does not cover any failure or problem unless it was caused solely by a defect in material or workmanship. In addition, this warranty shall not apply :

- If the water treatment equipment is not correctly installed, operated, repaired and maintained as described in the Installation, Operating & Maintenance Instructions Manual provided with the product.
- Defects caused as a direct result of the incoming water quality

710 Orange St, Ashland, OH 44805
PH 419-281-8962 | FAX 419-281-2375 | www.clearionwater.com
0323TV

- If the tank is not the size indicated for the supply line size of the installation, as described in the manual.
- To any failure or malfunction resulting from abuse (including freezing), improper or negligent; handling, shipping (by anyone)
- If the unit has not always been operated within the factory calibrated temperature limits, and at a water pressure not exceeding 125 psi other than Clearion), storage, use, operation, accident; or alteration, lightning, flooding or other environmental conditions;
- To any failure or malfunction resulting from failure to keep the unit full of potable water, free to circulate at all times; and with the tank free of damaging water sediment or scale deposits;
- This warranty does not cover labor costs, shipping charges, service charges, delivery expenses, property damage, administrative fees or any costs incurred by the purchaser in removing or reinstalling the water treatment equipment.
- The warranty does not cover any claims submitted to Clearion more than 30 days after expiration of the applicable warranty, and does not apply unless prompt notice of any claim is given to an authorized Clearion Dealer or to Clearion or a designated contractor is provided access to the installation and to the water treatment equipment.

THESE WARRANTIES ARE GIVEN IN LIEU OF ALL OTHER EXPRESS WARRANTIES. NO Clearion REPRESENTATIVE OR ANY OTHER PARTY IS AUTHORIZED TO MAKE ANY WARRANTY OTHER THAN THOSE EXPRESSLY CONTAINED IN THIS WARRANTY AGREEMENT.

Additional Warranty Limitations

ANY IMPLIED WARRANTIES THE PURCHASER MAY HAVE, INCLUDING THE IMPLIED WARRANTIES OF MERCHANTABILITY AND FITNESS FOR A PARTICULAR PURPOSE, SHALL NOT EXTEND BEYOND THE APPLICABLE TIME PERIODS SPECIFIED ABOVE. Some states do not allow limitations on how long an implied warranty lasts, so the above limitations may not apply to you.

Limitations of Remedies

The remedies contained in this warranty are the purchaser's exclusive remedies. In no circumstances will Clearion or the seller of the product be liable for more than, and purchaser-user's remedies shall not exceed, the price paid for the product. In no case shall Clearion or seller be liable for any special, incidental, contingent or consequential damages. Special, incidental, contingent and consequential damages for which Clearion is not liable include, but are not limited to, inconvenience, loss or damage to property, consequential mold damage, loss of profits, loss of savings or revenue, loss of use of the products or any associated equipment, facilities, buildings or services, downtime, and the claims of third parties including customers. Some states do not allow the exclusion or the limitation of incidental or consequential damages, so the above limitations or exclusion may not apply to you.

What to do if you have a problem covered by this warranty

Any warranty coverage must be authorized by Clearion. Contact the person from whom you purchased the product, who must receive authorization from a Clearion Dealer .

If your product is new and not used and you wish to return it, contact your Clearion Dealer.

